

**ASC**  
AMERICAN SOFTWARE'S CORP.

NES-7U-USA

TREASURE  
**MASTER™**  
THE ULTIMATE COMPETITION  
FOR FANTASY PRIZES

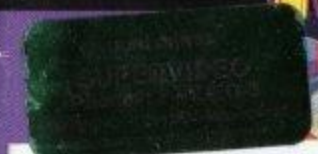

GAME PAK  
INSTRUCTIONS

IMPORTED BY NINTENDO  
OF AMERICA, INC.  
**Nintendo**  
ENTERTAINMENT  
SYSTEM™



**\$5.00**  
CASH REBATE by mail  
when you buy this game and six  
flexible candy bars (11.2 oz. or larger)  
Details inside.  
Offer expires 2/15/87





This official seal is your assurance that Nintendo® has reviewed this product and that it has met our standards for excellence in workmanship, reliability and entertainment value. Always look for this seal when buying games and accessories to ensure complete compatibility with your Nintendo Entertainment System®.

Licensed by Nintendo  
for play on the



Nintendo® and Nintendo Entertainment System® are trademarks of Nintendo of America Inc.

## PRECAUTIONS:

1. Always make sure the power to your NES Control Deck is **TURNED OFF** before inserting the **GAME PAK**.
2. This is a high precision game with complex electronic circuitry. It should not be stored in places that are very hot or cold. Never hit it or drop it. Never attempt to open it or take it apart.
3. Don't touch the connectors or get them wet or dirty; this will damage the game circuitry. Keep them clean by inserting the **GAME PAK** into its protective storage case.
4. Don't clean with benzine, paint thinner, alcohol or similar solvents.

**WARNING: DO NOT USE WITH FRONT OR REAR PROJECTION TV.** Do not use a front or rear projection television with your Nintendo Entertainment System® ("NES") and this video game. Your projection television screen may be permanently damaged if video games with stationary scenes or patterns are played on your projection television. Similar damage may occur if you place a video game on hold or pause. If you use your projection television with this video game, neither American Softworks Corporation nor Nintendo of America Inc. will be liable for any damage. This situation is not caused by a defect in the NES or this game; other fixed or repetitive images may cause similar damage to a projection television. Please contact your TV manufacturer for further information.

## ADVISORY

### READ BEFORE USING YOUR NES

A very small portion of the population may experience epileptic seizures when viewing certain kinds of flashing lights or patterns that are commonly present in our daily environment. These persons may experience seizures while watching some kinds of television pictures or playing certain video games. Players who have not had any previous seizures may nonetheless have an undetected epileptic condition. We suggest that you consult your physician if you have an epileptic condition or if you experience any of the following symptoms while playing video games: altered vision, muscle twitching, other involuntary movements, loss of awareness of your surroundings, mental confusion and/or convulsions.



## INTRODUCTION

Treasure Master is not your typical video game. It is "The Ultimate Quest for Fantasy Prizes." It is a competition that you are invited to participate in. You don't have to compete if you don't want to. You can still just challenge the game as you would any other NES game, but you've got nothing to lose...and plenty to win...so why not go for it?

As with any contest or competition, there are specific rules that must be observed. These are covered in the back of this manual, in the section entitled "Official Competition Rules." Please read these over very carefully.

### **DO NOT BEGIN PLAYING UNTIL YOU HAVE REVIEWED THE RULES.**

Once you understand what Treasure Master is all about give it your best shot. Winning will depend upon your playing skills and ability.

Enjoy yourself. We look forward to hearing from you in the future on the "Winner's Hotline." Circle April 11, 1992 on your calendar as the day to get the contest password.



## TREASURE MASTER-The Story

Skooter is a typical kid. He usually has a lot of stuff going on. You know, like playing ball...riding his skateboard or just messing around with his friends. The problem is that none of this is really exciting or adventurous. Well, all that changed on the day that Skooter found the coin...an old, beat up gold coin.

It was the size of a standard quarter, but it had a lot of strange markings on it. Markings that Scooter couldn't read. It was also very heavy. When he first picked it up, he was surprised by how much it weighed. Skooter was puzzled by his discovery and decided to find out where this coin came from. He really wanted to know what it said. He left the coin under his pillow at home for safe keeping and started to go to the library everyday after school. He went through book after book looking for any clue. For weeks he spent at least an hour a day in the library and for weeks he was unable to find even the smallest hint. Not a picture, not a drawing...nothing.

At the same time, he started having the strangest dreams. They weren't nightmares...even though they were kind of scary... they were more like "fantasy adventure dreams". He would see himself traveling through



fantastic worlds of bizarre landscapes in weird colors...and he was always alone. There were no other people in these dreams. Except, of course, for a fantastic assortment of evil characters that would try to prevent him from traveling on. It didn't take Skooter long to figure out that these were not ordinary dreams. He found himself not being able to tell when he was actually awake and when he was dreaming. It had to be connected to the coin. The day Skooter put the coin under his pillow was also the day the dreams began.

Weeks later, he finally stumbled onto the book he was looking for. It was a book called "The Legend of the Treasure Master" and it told the story of a strange man and his even stranger ideas. His name was Ocsiban and he was considered to be a sorcerer, a genius and sometimes a fool. He spent his entire life trying to convince people that there was a great treasure hidden somewhere and it could be found by anyone. Anyone, that is, that had courage. Ocsiban said to find the treasure one had to endure a "quest". Once that was started, there was no turning back. The adventurer would have to continue until the treasure was found...or be lost forever. The places that the quest would take him/her to would not be real, but at the same time would seem quite real, because they were places in the mind.

Finally, he spoke of a coin that would be a key, but its secret would only be understood by "a chosen one". This person had to have great

courage to accept the challenge and the imagination to enter their own fantasy world.

Skooter knew it would be dangerous and he would be taking a terrible chance if he attempted the quest, but there was never a moment of doubt in his mind. That night, Skooter set out on an adventure that would take him to places where no one had traveled before... worlds within his imagination. The quest to become a Treasure Master would be the adventure of a lifetime.

## GETTING STARTED

1. Make sure your Nintendo Entertainment System® is shut off, then put the Treasure Master GAME PAK in the system.
2. Press the POWER button in the front of the system. The title and copyright screen appears, then the best score / high score screen.
3. Make sure the controller is plugged into socket 1.
4. Push START to begin.\*

\* If you are participating in the Treasure Master competition, enter the Serial Number from your Game Registration Card and the Secret Password before pushing START. (See instructions on pages 6 and 7.)



## OPERATING INSTRUCTIONS

Controller 1- For 1 player

Controller 2- Not used

### Control Pad:

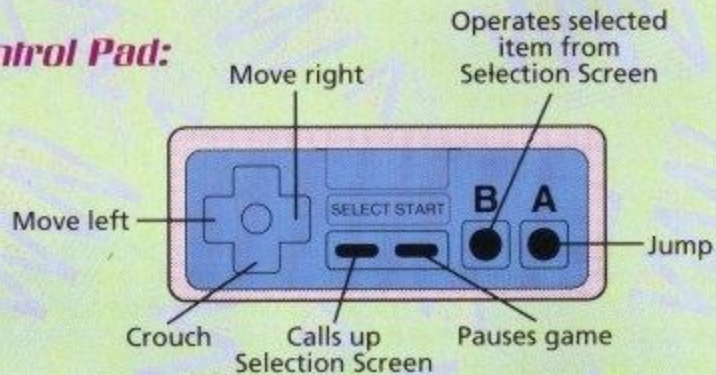

UP and A BUTTON: Catch or climb.

DOWN and A BUTTON: Exit any vehicle or blow up a bomb.

## ENTERING YOUR REGISTRATION NUMBER & THE SECRET PASSWORD

If you are participating in the Treasure Master competition, you must first enter both the Serial Number which appears on the bottom of your Game Registration Card and the Secret Password which will be announced on April 11, 1992. (See the Official Competition Rules at Page 20 of this instruction booklet to learn how to discover the Secret Password.)

To enter your Serial Number and Secret Password, follow steps 1, 2, and 3 under "Getting



Started." Do not push START to begin. Instead, wait for the music to begin on title screen, then press SELECT.



At the top of the screen, you will see a ring of numbers around spaces for your 8-digit Serial Number. Use the UP ARROW to make sure you are positioned to enter your Serial Number. Then rotate the ring with the LEFT and RIGHT ARROWS, so the first digit of your Serial Number is showing in the box. Pressing the A BUTTON will place the number in position on the screen. Rotate the ring until the second digit of your Serial Number is in the box. Pressing the A BUTTON will place it on the screen. Pressing the B BUTTON will erase the last number so you can correct mistakes. Continue until you have all 8 digits of your Serial Number in the correct order. Use the DOWN ARROW to move the ring which appears around spaces for the 24-digit Secret Password. Use the A and B BUTTONS just as you did before to enter the Secret Password. When you have entered all 24 numbers or letters correctly, press START to begin the game and the competition.

Be very careful when entering your Serial Number and the Secret Password. If any number or letter of the Secret Password is incorrect, you will not be able to gain entrance to the final level (Prize World) of the game. If your Serial Number does not match the one on your Game Registration Card, you will not be eligible to win a prize, so check your work before starting the game.

## THE QUEST

Treasure Master consists of many worlds you must explore. All of them are completely different. Remember, once your quest has begun, there is no turning back. The game offers no shortcuts. In other words, it must be played straight through from start to finish. If you fail to complete your quest, you will automatically go back to the beginning of the game.

You start out with four lives. Your energy level decreases if an enemy hits, shoots or runs into you, so watch out! Some enemies are more dangerous than others and will cause you to lose a complete life if you are not careful. There are many other perilous hazards, as well, that will do the same. The quest ends when the player reaches the treasure or runs out of lives. You can restore your life count by collecting the many hidden bonuses scattered throughout the worlds.

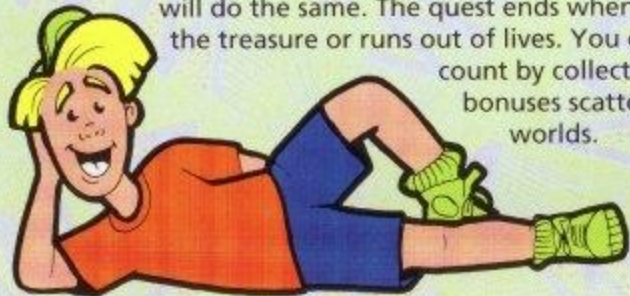



## THE WORLDS:

Every world you will encounter will be challenging, yet rewarding. You must complete each and every world from start to finish in order to become a Treasure Master. THERE ARE NO SHORT CUTS! Some of the worlds you will explore are:

### *The Islands:*

Though there is sun and sand, this is not your typical island paradise. This action packed romp takes you underwater, into the sky and all over the island. The not-so-friendly inhabitants will make your island visit something you won't soon forget!



### *Microchip:*

WOW! Be the first to play inside of your Nintendo Entertainment System®. A maze of circuits, transistors and chips awaits you...but watch out for those nasty computer bugs and other not-so-nice surprises. Just remember the importance of TRANSMUTATION!





## *The Moon:*

You can boldly go where no man has gone before...inside the moon! Fall through craters that will drop you into a world of moving platforms, flying saucers, buzz saw blimps and renegade robots. Keep an eye out for a special vehicle that can help you travel through this world...if you are clever enough to find it and learn how to drive it!



## *Other Worlds:*

In your quest to become a Treasure Master you can never be sure what worlds you'll have to conquer or the enemies you'll have to face. Good luck!





## YOUR ENEMIES:

Here are some of the baddies who will try to make your quest very difficult...if you let them:



**Monster  
Sharks**



**Mutant  
Dragonflies**



**Blitz  
Blimps**



**Savage  
Springs**

**Power  
Puffs**



**Cosmic  
Caterpillars**

**Sonic  
Saucers**

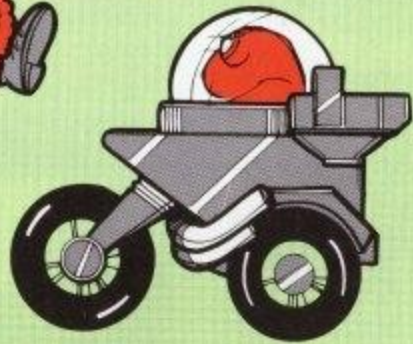
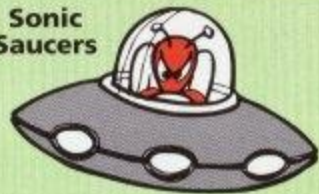

**Solar  
Road Hogs**

## TOOLS OF THE TRADE:

Being a Treasure Master requires knowing how to use an assortment of strange and unique accessories. Here are some of the useful tools that will help get you through the various worlds:



Space Hopper



Mutation Credit



Magic Apple



Hard Hat



Bombs

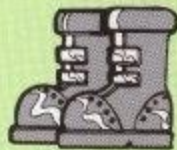

Radium Plated Boots



Control Box



Moon Buggy



Machine Part



Enhancement Goggles



Oxygen



Simple Door Key



Scissors



Construction Potion



Bow & Arrow



Raygun



Command Card



Radio Beacon



ID Card



## TYPICAL SCREEN:



## SELECTION SCREEN:

Note: The LEFT and RIGHT arrows will let you switch between collected tools.



# OFFICIAL COMPETITION RULES



# Treasure Master™

## The Ultimate Quest for Fantasy Prizes

### Official Competition Rules

#### Eligibility

Players of the Treasure Master Game of any age (except in those states mentioned below) are invited to participate in the competition. The competition period will begin at 12:00 noon EST on April 11, 1992 and will end at 12:00 midnight EST on April 11, 1992 or whenever all prizes have been awarded, whichever comes first. Prizes won by players under 18 years of age will be awarded to the winner's parents or legal guardian. The Treasure Master competition is open to all US residents, except in those states where any aspect of the competition is taxed, prohibited or restricted by law, including the states of Arizona, Louisiana, Montana and Vermont. Employees of American Softworks Corporation and Nintendo of America Inc., their affiliates, distributors, advertising agencies, printers and product designers and consultants and their employees and families are not eligible. Void where taxed, prohibited or restricted by law. All taxes applicable to any prizes will be the sole responsibility of prize winners. All federal, state and local laws apply.

#### Conditions

##### In order to win, eligible players must:

##### 1. Mail in Part II of Game Registration Card

Players must complete and return Part II of the special two-part Treasure Master game registration card so as to be received no later than 12:00 midnight EST on

April 8, 1992. Timely receipt of registration cards will be verified by an independent fulfillment organization. Identical serial numbers are printed at the bottom portion of both parts of the game registration card. Players must keep the other part marked "KEEP THIS CARD" as these serial numbers will be used to verify the identity of players who have mailed in Part II of the game registration card and who have successfully completed the game portion of the competition (see below).

##### 2. Discover the Secret Password

Between 12:00 noon EST and 1:00 P.M. EST on April 11, 1992, the Secret Password will be announced on MTV Music Television™. The Secret Password may also be obtained during the competition period by calling our special Treasure Master competition telephone number 1-900-370-TREASURE beginning at 12:00 noon EST on April 11, 1992. Call will cost \$.50 per minute. Children under 18 ask your parents first. Average length of call is 3 minutes. After the competition period ends, the Secret Password may be obtained by writing to us at Treasure Master Secret Password, c/o American Softworks Corporation, 228 East 45th Street, New York, New York 10017. Please enclose a self-addressed, stamped envelope.

##### 3. Complete Game Portion

Once a player has learned the Secret Password, he or she must carefully enter the Secret Password by using his or her NES controller at the beginning of the Treasure Master Game. (See pages 6-7 under operating instructions.) A player who has entered the correct Secret Password must then successfully complete all five worlds (levels) of normal game play. Upon completion of the fifth world (level), players who have entered the correct Secret Password will be able to enter a special PRIZE WORLD (level).



#### 4. Call WINNER'S HOTLINE

Players who are able to successfully complete the special PRIZE WORLD will be instructed on screen to call the special WINNER'S HOTLINE, 1-900-370-U-WIN. Call will cost \$.85 per minute. Children under 18 ask your parents first. Average length of call is 3 minutes. Operators will be available from 12:00 noon EST April 11, 1992 through 12:00 midnight EST April 11, 1992 to accept players' calls. To verify players' identity and successful completion of the game portion of the Treasure Master competition, operators will ask that players repeat the serial number which is printed on the bottom portion of Part I of the game registration card and state the identification number which appears at the end of the PRIZE WORLD. (NOTE: Identification numbers are unique to each individual Treasure Master Game Pak.) All winner determinations shall be made under the supervision of an independent fulfillment organization whose decision shall be final and binding on all matters relating to this competition.

#### PRIZES

Subject to all other terms and conditions of these Official Game Rules, prizes will be awarded to the first 36,252 eligible competitors whose game registration cards have been received by April 8, 1992 and who have successfully completed the game portion of the competition, including the PRIZE WORLD, and who have called our WINNER'S HOTLINE to verify eligibility and successful completion of the game during the competition period. Two (2) grand prizes will be awarded to the first two (2) eligible winners who call the WINNER'S HOTLINE during the competition period. Two hundred fifty (250) second prizes will be awarded to the next two hundred fifty (250) winners who call the WINNER'S HOTLINE during the competition period. Thereafter, third prizes will be awarded to the next 36,000 eligible winners who call the WINNER'S HOTLINE between 12:00 noon EST April 11, 1992 and 12:00 midnight EST April 11, 1992.

#### PRIZES (cont'd.)

1. One Grand Prize will be awarded to each of the first two verified eligible winners. Grand prize winners may choose one of the following:
    - a) Fantasy Rock Concert - Travel for the Winner and three (3) family members or friends to one of a number of selected major rock music concerts to be held in a major US city during the 12 month period following the competition; hotel accommodations, ground transportation and best available concert seats; plus \$5,000 spending money; or
    - b) Fantasy Sports Event - Travel for the Winner and three (3) family members or friends to one of a number of selected major sports events to be held during the 12 month period following the competition in a major US city; hotel accommodations, ground transportation and best available seats; plus \$5,000 spending money; or
    - c) Fantasy Audio/Video Room - Big screen (50 inch) TV; Super NES™ and 12 Super NES Game Paks; a brand name audio system fully installed anywhere in the United States; or
    - d) \$10,000.00
  2. The next 250 verified eligible Second Prize winners each will receive:
    - A Super NES™
  3. The next 36,000 verified eligible Third Prize winners will receive:
    - Official Poster-Size Winner's Certificate.
- In the event that there are fewer than 36,000 eligible verified Third Prize winners, the remaining Third Prizes will not be awarded.



All departures and accommodations are subject to space availability; air travel is round trip, economy class by major U.S. carrier from airport nearest Winner's home in U.S. Hotel accommodations are for three days/two nights (two rooms; double occupancy). Fantasy Rock Concert and Fantasy Sports Event must be selected from a list supplied by American Softworks Corporation and all travel must be completed by April 12, 1993. Audio System features brand name AM/FM stereo tuner, amplifier, cassette deck, CD player and two speakers. No transfers or substitutions of prizes, except by American Softworks Corporation, dependent upon product availability. Only one prize may be claimed per Game Pak purchased. Approximate retail value of Grand Prize is \$10,000. Approximate retail value of Second Prize is \$200.00; and approximate retail value of Third Prize is \$5.00.

#### **Announcement of Prize Winners**

Grand Prize winners will be announced on our WINNER'S HOTLINE, 1-900-370-U-WIN. Call will cost \$.85 per minute. Children under 18 ask your parents first. Average length of call is 3 minutes. Winners of Grand Prizes and Second Prizes will also be confirmed by mail within 5 days of the end of the competition period. Winners of Second and Third Prizes will receive their prizes by mail. (Allow 8 weeks for delivery.) Lists of Grand Prize and Second Prize winners may be obtained by sending a self-addressed, stamped envelope to:

Treasure Master Competition, c/o American Softworks Corporation  
228 East 45th Street, New York, New York 10017.

#### **Other Rules and Conditions**

Winners of Grand Prizes and Second Prizes will be required to sign and complete an official affidavit of eligibility and release and any applicable forms required by tax authorities which must be received within 14 days or prize will be forfeited. Winner's entry and acceptance of any prize constitutes permission to use winner's name, photograph, address and/or other likeness for purposes of advertising and/or promotion and winner grants to American Softworks Corporation all rights to said use without additional consideration. Should any prize claimant be found to have violated any of these rules or any applicable laws, such claimant will be disqualified even if he or she has been selected as a winner. Winners agree that American Softworks Corporation, Nintendo of America Inc. and their affiliates, their advertising, promotion and judging agencies, and their affiliates, agents and employees shall have no liability in connection with the acceptance, operation or use of the prizes awarded herein and acknowledge that none of such parties has made or is in any matter responsible for any warranties, representations or guarantees, expressed or implied, relating to any prize, including its conditions or fitness. American Softworks Corporation will not be responsible for any loss, delay, damage or misdirection of mail, telephone calls or other communications, unavailability of 900 exchange telephone service in certain localities, printing errors in entry forms or Official Competition Rules or any other event or condition beyond its reasonable control in connection with this competition. American Softworks Corporation will in no event be responsible to award any prizes in excess of the number listed in these Official Competition Rules. American Softworks Corporation reserves the right at any time, without further obligation or liability, to cancel this competition at any time.



Nintendo of America Inc. is neither a sponsor of nor affiliated with the Treasure Master competition and expressly disclaims any responsibility for the conduct or administration of the competition.

### Caution/Warning

The use of any game altering devices will cause an invalid prize identification number to appear on screen at the end of the Prize World or will prevent successful completion of the game and therefore result in disqualification.

MTV Music Television™ is a trademark of MTV Networks.

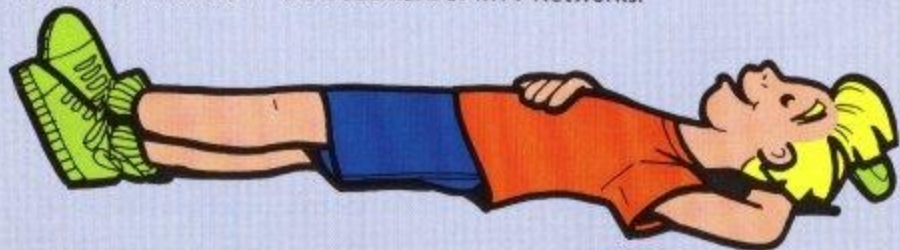

**AMERICAN SOFTWARES CORPORATION™**, 228 East 45th Street, New York, NY 10017  
ASC™ and TREASURE MASTER™ are trademarks of American Softworks Corporation. Nintendo® and Nintendo Entertainment System® are trademarks of Nintendo of America Inc. ©1991 American Softworks Corporation. Game Pak \*NES-GP.\* All rights reserved. Printed in Japan.

Designed and programmed by **SOFTWARE CREATIONS, LTD.**

### ASC™ 90 Day Limited Warranty

AMERICAN SOFTWARES CORPORATION ("ASC") warrants to the original consumer purchaser of this software product that the medium on which the computer program is recorded will be free from defects in materials and workmanship for a period of ninety (90) days from the date of purchase under normal home use. The computer program is sold "as is" without express or implied warranty of any kind and ASC will not be liable for any loss or damage of any kind from use of this program. If a defect covered by this warranty occurs during the 90-day warranty period, ASC will repair or replace the product, at its option, free of charge.

#### TO RECEIVE THIS WARRANTY SERVICE:

1. DO NOT return your defective product to the retailer.
2. Notify ASC Consumer Service Department of the problem requiring Warranty service by calling: 1-212-972-6262. Our Consumer Service Department is in operation from 9:00 am to 5:00 pm Eastern Standard Time, Monday through Friday. Please DO NOT send your product to ASC before calling our Consumer Service Department.
3. If our ASC Service Representative is unable to solve the problem by phone, you will be provided with a Return Authorization Number. Simply record this number on the outside of your packaging of your defective product and return it **FREIGHT PREPAID AND INSURED FOR LOSS OR DAMAGE**, together with your sales slip or similar proof-of-purchase, within this 90-day Warranty period to:

American Softworks Corporation, Consumer Service Department, 228 East 45th Street, New York, NY 10017.

#### WARRANTY LIMITATIONS:

ALL IMPLIED WARRANTIES, INCLUDING WARRANTIES OF MERCHANTABILITY AND FITNESS FOR A PARTICULAR PURPOSE, ARE LIMITED TO NINETY DAYS FROM THE DATE OF PURCHASE AND ARE SUBJECT TO THE CONDITIONS SET FORTH HEREIN. ASC WILL NOT BE LIABLE FOR CONSEQUENTIAL OR INCIDENTAL DAMAGES RESULTING FROM THE BREACH OF ANY EXPRESS OR IMPLIED WARRANTIES.

The provisions of this warranty are valid in the United States only. Some states do not allow limitations on how long an implied warranty lasts or exclusion of consequential or incidental damages, so the above limitations and exclusion may not apply to you. This warranty gives you specific legal rights, and you may also have other rights which vary from state to state.

This warranty will not apply if the product has been damaged while in your possession, by negligence, accident, abuse or tampering, or by other causes unrelated to defective material or workmanship.

### COMPLIANCE WITH FCC REGULATIONS

This equipment generates and uses radio frequency energy and if not installed and used properly, that is, in strict accordance with the manufacturer's instructions, may cause interference to radio and television reception. It has been type tested and found to comply with the limits for a Class B computing device in accordance with the specifications in Subpart J of Part 15 of FCC Rules which are designed to provide reasonable protection against such interference in a residential installation. However, there is no guarantee that interference will not occur in a particular installation. If this equipment does cause interference to radio or television reception, which can be determined by turning the equipment off and on, the user is encouraged to try and correct the interference by one or more of the following measures:

- Reorient the receiving antenna
- Relocate the NES with respect to the receiver
- Move the NES away from the receiver.
- Plug the NES into a different outlet so that the computer and receiver are on different circuits.

If necessary, the user should consult an experienced radio/television technician for additional suggestions. The user may find the following booklet prepared by the Federal Communications Commission helpful. How to identify and Resolve Radio-TV Interference Problems. This booklet is available from the U.S. Government Printing Office, Washington, DC 20402.

## NESTLE \$5.00 CASH REBATE OFFER

To receive your \$5.00 cash rebate offer by mail, just send in this completed certificate along with 6 proofs-of-purchase (UPC symbols) from any Nestle candy bars (1.4 oz. or larger), your cash register receipt from Treasure Master™ and one UPC code from Treasure Master Game Pak to the address below:

**Nestle/Treasure Master \$5.00 Cash Rebate Offer**  
**P.O. Box 8578**  
**Young America, MN 55551-8578**

NAME \_\_\_\_\_  
(Please print)

ADDRESS \_\_\_\_\_ Apt.# \_\_\_\_\_

CITY \_\_\_\_\_

STATE/ZIP \_\_\_\_\_

Not responsible for lost or misdirected mail. No proofs other than those specified will be accepted. Limited one (1) \$5.00 rebate offer per family, household, or address. Offer good only in U.S.A. Void where prohibited, taxed, or restricted. Rebate certificates which are incomplete, mechanically reproduced or illegible will not be accepted. Please allow 6-8 weeks for delivery. Redemption requests must be postmarked by 3/15/92.

(Cut along dotted line)





AMERICAN SOFTWARE CORP.

PRINTED IN JAPAN